

GEDA S.R.L.
 33080 Porcia (PN)- ITALY
 VIA MAESTRI DEL LAVORO,16/18
 TEL.+ 39 0434 923077
 FAX.+ 39 0434 591923
 info@gedanextage.com
 www.gedanextage.com



DENOMINAZIONE

MIK DOCCIA INCASSO CON D. ROTATIVO 3 VIE

CODICE

MIK29

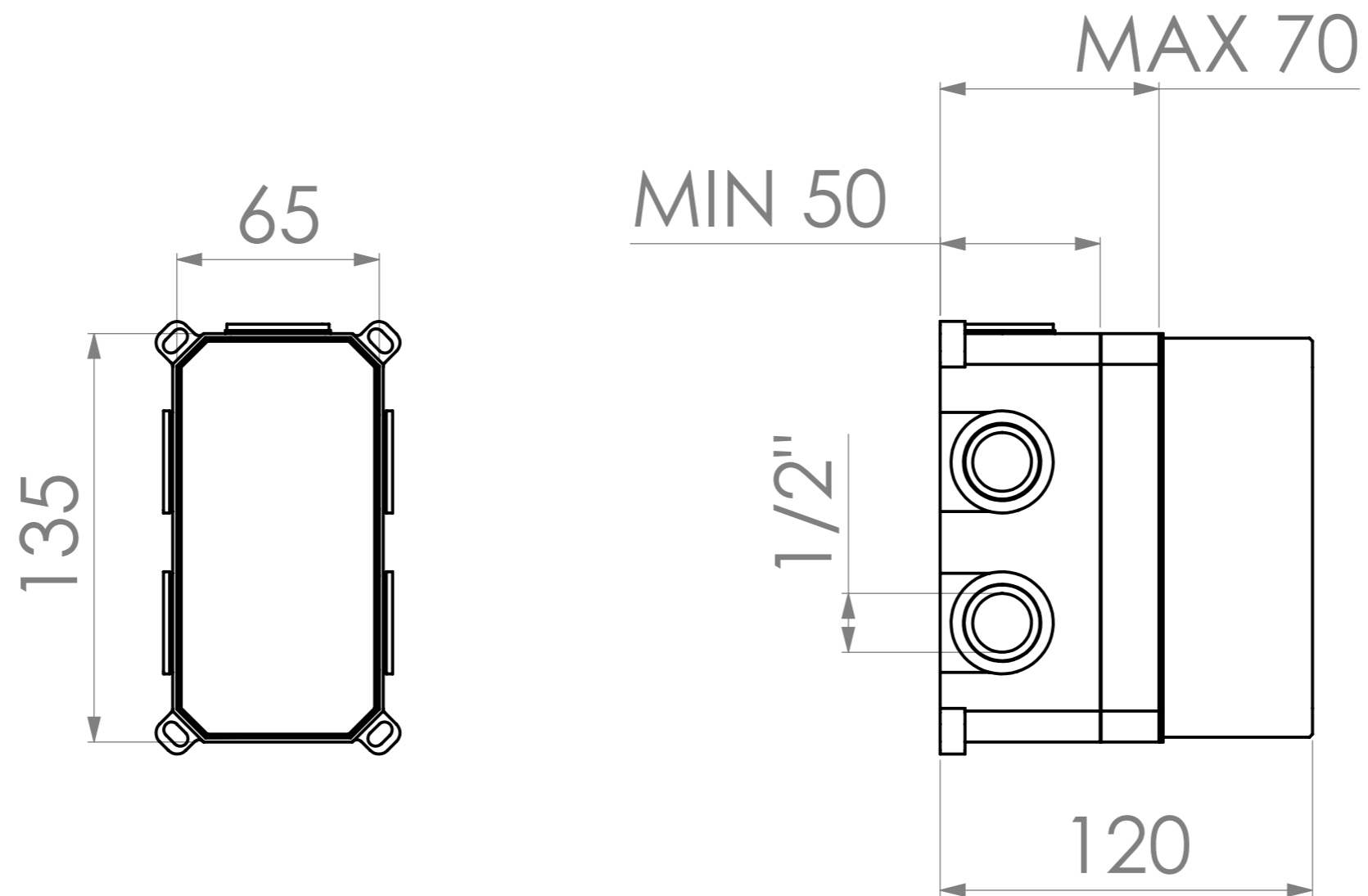

GEDA S.R.L
 33080 Porcia (PN)- ITALY
 VIA MAESTRI DEL LAVORO,16/18
 TEL.+ 39 0434 923077
 FAX.+ 39 0434 591923
 info@gedanextage.com
 www.gedanextage.com



DENOMINAZIONE

PARTE INCASSO CON DEVIATORE ROTATIVO 3 VIE OTTONE

CODICE

IST29